

# INSTALLATION INSTRUCTION MANUAL

## S1 ETS1, S1 ETM1, S1 ESD1

**minilec**<sup>®</sup>



### MOUNTING

These RELAYS are suitable for DIN RAIL and WALL mounting.

### CAUTION

- Ensure that all above relays are -
  - \* Not installed near any heat sources like Burner, Sunlight, Electric arc etc.
  - \* Not subjected to abnormal vibration.
  - \* Installed as near to starter as possible.
  - \* Not subjected to Direct heat, Sunlight, Rain.
- If the product is not installed as per guideline given by minilec, our company will not be responsible for any wrong connection, damage, injury, accident, etc.

### ELECTRICAL CONNECTION IN POWER & CONTROL WIRING FOR S1 ETS1, S1 ETM1

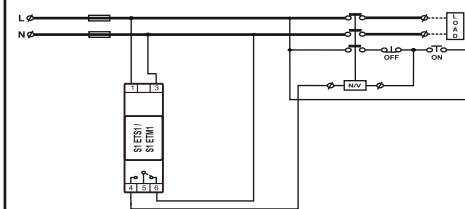

NOTE :- RELAY CONTACTS SHOWN FOR RELAY IN POWER OFF CONDITION.

### ENCLOSURE DIMENSIONS

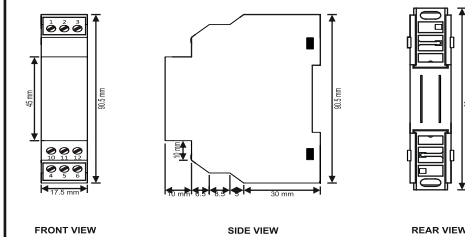

### TERMINAL DETAILS: S1 ETS1, S1 ETM1

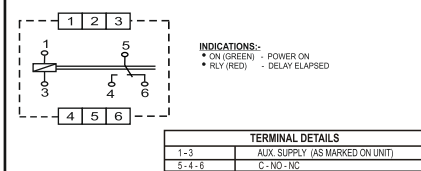

INDICATIONS:-  
 • ON (GREEN) - POWER ON  
 • RLY (RED) - DELAY ELAPSED

TERMINAL DETAILS	
1-3	AUX. SUPPLY (AS MARKED ON UNIT)
5-4-6	C - NO-NC

- NOTES :-
- AUX. SUPPLY TO BE CONNECTED AS MENTIONED ON THE UNIT.
  - RELAY CONTACTS SHOWN FOR POWER OFF CONDITION.
  - FOR DC SUPPLY CONNECT +VE TO 1 AND -VE TO 3 TERMINAL

### TERMINAL DETAILS: S1 ESD1

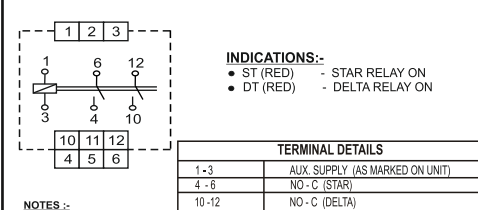

INDICATIONS:-  
 • ST (RED) - STAR RELAY ON  
 • DT (RED) - DELTA RELAY ON

TERMINAL DETAILS	
1-3	AUX. SUPPLY (AS MARKED ON UNIT)
4 - 6	NO - C (STAR)
10-12	NO - C (DELTA)

- NOTES :-
- AUX. SUPPLY TO BE CONNECTED AS MENTIONED ON THE UNIT.
  - RELAY CONTACTS SHOWN FOR POWER OFF CONDITION.
  - FOR DC SUPPLY CONNECT +VE TO 1 AND -VE TO 3 TERMINAL

### COMPLIANCE TO STANDARDS

TEST	IES STD
1. EFT Test of Auxiliary Supply	61000-4-4
2. Surge Test of Auxiliary Supply	61000-4-5
3. Voltage Interruption, Variation & Dip Test	61000-4-11
4. ESD Test (Contact Discharge)	61000-4-2
5. ESD Teast (Air Discharge)	61000-4-2
6. H.V. Test (Dielectric Test)	60255-5
7. Insulation Resistance Test	60255-5
8. Dry Heat Test	60068-2-2
9. Damp Heat test (Steady State)	60068-2-30
10. Damp Heat test (cyclic test)	60068-2-78

### TECHNICAL SPECIFICATION

SR. NO.	PARAMETERS	S1 ETS1	S1 ETM1	S1 ESD1
1.	SYSTEM SUPPLY VOLTAGE	100-120 / 220-240 / 380-440 VAC ± 15% 12VDC / 24VDC / 24VAC (-10% + 15%)	100-120 / 220-240 / 380-440 VAC ± 15% 12VDC / 24VDC / 24VAC (-10% + 15%)	100-120 / 220-240 / 380-440 VAC ± 15% 12VDC / 24VDC (-10% + 15%)
2.	FREQUENCY	50 Hz / 60 Hz.	50 Hz / 60 Hz.	50 Hz / 60 Hz.
3.	POWER CONSUMPTION	28 VA Max.	28 VA Max.	28 VA Max.
4.	OUTPUT RELAY CONTACTS	1CO	1CO	1NO FOR STAR & 1NO FOR DELTA
5.	OUTPUT CONTACT RATING	5 Amp, 240VAC [RESISTIVE]	5 Amp, 240VAC [RESISTIVE]	5 Amp, 240VAC [RESISTIVE]
6.	LIFE EXPECTANCY	0.5 X 10 <sup>6</sup> OPERATIONS	0.5 X 10 <sup>6</sup> OPERATIONS	0.5 X 10 <sup>6</sup> OPERATIONS
7.	SET ACCURACY	± 5% OF FULL SCALE	± 5% OF FULL SCALE	± 5% OF FULL SCALE
8.	REPEAT ACCURACY	LESS THAN ± 1% AT RATED AUX. SUPPLY AT 25°C A) For temp. variation of 25°C to 60°C : ±3% Max of set value B) For supply variation of 10% : ±3% Max of set value C) For frequency variation of 1% : ±2% Max of set value		
9.	TIME RANGES	0 - 10 Sec / 0 - 30 Sec / 0 - 60 Sec	0 - 30 Min / 0 - 60 Min	-----
	STAR TIME	-----	-----	0.75 - 60 Sec
	STAR TO DELTA TRANSFER TIME	-----	-----	50 - 100 mSec
10.	RESETTING	AT POWER ON, RESET TIME < 200mSec	AT POWER ON, RESET TIME < 200mSec	AT POWER ON, RESET TIME < 200mSec
11.	INDICATIONS	• ON / ST • RLY / DT	POWER ON RELAY ON	STAR RELAY ON DELTA RELAY ON
13.	ENCLOSURE	17.5mm S1 SERIES - ABS / PC - ABS	17.5mm S1 SERIES - ABS / PC - ABS	17.5mm S1 SERIES - ABS / PC - ABS
14.	DIMENSIONS ( mm )	• OVERALL (L X W X D)		
		96 x 17.5 x 60	96 x 17.5 x 60	96 x 17.5 x 60
15.	MOUNTING	35mm DIN RAIL AND WALL MOUNTING	35mm DIN RAIL AND WALL MOUNTING	35mm DIN RAIL AND WALL MOUNTING
16.	OPERATING CONDITIONS	TEMPERATURE = -5 °C TO +60 °C HUMIDITY = UPTO 95% Rh.	TEMPERATURE = -5 °C TO +60 °C HUMIDITY = UPTO 95% Rh.	TEMPERATURE = -5 °C TO +60 °C HUMIDITY = UPTO 95% Rh.
17.	WEIGHT (APPROX.)	90 gms.	90 gms.	120 gms.

### TIMING DIAGRAM FOR S1 ETS1, S1 ETM1

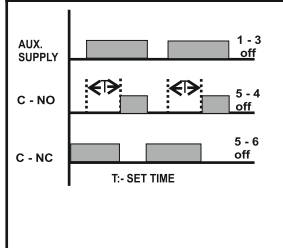

### FUNCTIONING

Set the desired time by front potentiometer. Before Aux. supply voltage is switched on, output relay contacts are in de-energised state (NO). After switching ON the supply, the Timer starts counting the timing and when set time delay elapses the o/p contact change their state from original status. (From NO to NC)

### RESETTING :-

Unit will reset only if Aux. supply of unit is removed from the point 1 and 3. And will restart its Set time Cycle when unit is switched ON.

### TIMING DIAGRAM FOR S1 ESD1

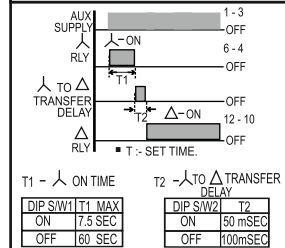

### FUNCTIONING

Set the desired STAR time by DIP SW 1 & front potentiometer & STAR to DELTA transfer time by DIP SW 2.  
 Before Aux. Supply voltage is switched on both relay contacts are in de-energised state (NO). After switching ON the supply, STAR relay is energised. After the set STAR time (T1), STAR relay is de-energised.  
 For the set STAR to DELTA Transfer time (T2) both relays remain de-energised. At the end of T2, DELTA relay is energised & remain ON till power is ON.

### RESETTING :-

S1 ESD1 unit will reset only if Aux. supply of unit is removed from the point 1 & 3 and will restart its set time cycle when unit is switched ON.

### TYPICAL APPLICATION DIAGRAM FOR STAR-DELTA STARTER MODE FOR S1ESD1

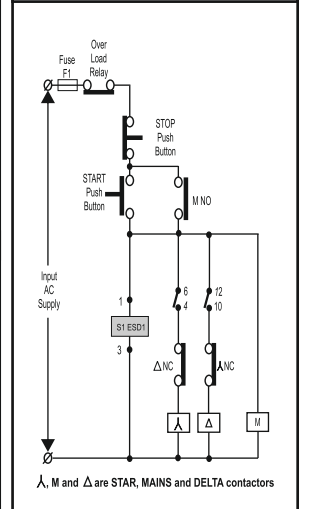

**WARRANTY - AGAINST ALL MANUFACTURING DEFECTS FOR 18 MONTHS FROM DATE OF SUPPLY OR 12 MONTHS FROM INSTALLATION WHICHEVER IS EARLIER**

[www.minilecgroup.com](http://www.minilecgroup.com)

Version 07 (01/12/2022)